

Anti-Parallel
APT2X100D20J

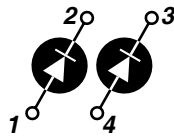

Parallel
APT2X101D20J

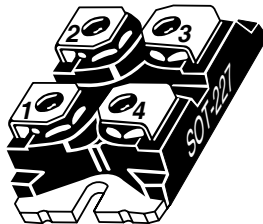

APT2X101D20J 200V 100A
APT2X100D20J 200V 100A

DUAL DIE ISOTOP® PACKAGE

ULTRAFAST SOFT RECOVERY RECTIFIER DIODE

PRODUCT APPLICATIONS

- Anti-Parallel Diode
 - Switchmode Power Supply
 - Inverters
- Free Wheeling Diode
 - Motor Controllers
 - Converters
- Snubber Diode
- Uninterruptible Power Supply (UPS)
- Induction Heating
- High Speed Rectifiers

PRODUCT FEATURES

- Ultrafast Recovery Times
- Soft Recovery Characteristics
- Popular SOT-227 Package
- Low Forward Voltage
- High Blocking Voltage
- Low Leakage Current

PRODUCT BENEFITS

- Low Losses
- Low Noise Switching
- Cooler Operation
- Higher Reliability Systems
- Increased System Power Density

MAXIMUM RATINGS

All Ratings: $T_C = 25^\circ\text{C}$ unless otherwise specified.

Symbol	Characteristic / Test Conditions	APT2X101_100D20J	UNIT
V_R	Maximum D.C. Reverse Voltage	200	Volts
V_{RRM}	Maximum Peak Repetitive Reverse Voltage		
V_{RWM}	Maximum Working Peak Reverse Voltage		
$I_F(AV)$	Maximum Average Forward Current ($T_C = 102^\circ\text{C}$, Duty Cycle = 0.5)	100	Amps
$I_F(RMS)$	RMS Forward Current (Square wave, 50% duty)	171	
I_{FSM}	Non-Repetitive Forward Surge Current ($T_J = 45^\circ\text{C}$, 8.3ms)	1000	
T_J, T_{STG}	Operating and Storage Temperature Range	-55 to 150	$^\circ\text{C}$

STATIC ELECTRICAL CHARACTERISTICS

Symbol		MIN	TYP	MAX	UNIT	
V_F	Forward Voltage		$I_F = 100\text{A}$	1.0	1.1	Volts
			$I_F = 200\text{A}$	1.4		
			$I_F = 100\text{A}, T_J = 125^\circ\text{C}$	0.9		
I_{RM}	Maximum Reverse Leakage Current		$V_R = V_R \text{ Rated}$		500	μA
			$V_R = V_R \text{ Rated}, T_J = 125^\circ\text{C}$		1000	
C_T	Junction Capacitance, $V_R = 200\text{V}$		400		pF	

DYNAMIC CHARACTERISTICS

APT2X101_100D20J

Symbol	Characteristic	Test Conditions	MIN	TYP	MAX	UNIT
t_{rr}	Reverse Recovery Time	$I_F = 1A, di_F/dt = -100A/\mu s, V_R = 30V, T_J = 25^\circ C$	-	39		ns
t_{rr}	Reverse Recovery Time	$I_F = 100A, di_F/dt = -200A/\mu s, V_R = 133V, T_C = 25^\circ C$	-	60		
Q_{rr}	Reverse Recovery Charge		-	200		nC
I_{RRM}	Maximum Reverse Recovery Current		-	6	-	Amps
t_{rr}	Reverse Recovery Time	$I_F = 100A, di_F/dt = -200A/\mu s, V_R = 133V, T_C = 125^\circ C$	-	110		ns
Q_{rr}	Reverse Recovery Charge		-	840		nC
I_{RRM}	Maximum Reverse Recovery Current		-	15	-	Amps
t_{rr}	Reverse Recovery Time	$I_F = 100A, di_F/dt = -1000A/\mu s, V_R = 133V, T_C = 125^\circ C$	-	80		ns
Q_{rr}	Reverse Recovery Charge		-	1910		nC
I_{RRM}	Maximum Reverse Recovery Current		-	44		Amps

THERMAL AND MECHANICAL CHARACTERISTICS

Symbol	Characteristic / Test Conditions	MIN	TYP	MAX	UNIT
$R_{\theta JC}$	Junction-to-Case Thermal Resistance			.33	$^\circ C/W$
$R_{\theta JA}$	Junction-to-Ambient Thermal Resistance			20	
W_T	Package Weight		1.03		oz
			29.2		g
Torque	Maximum Terminal & Mounting Torque			10	lb•in
				1.1	N•m

APT Reserves the right to change, without notice, the specifications and information contained herein.

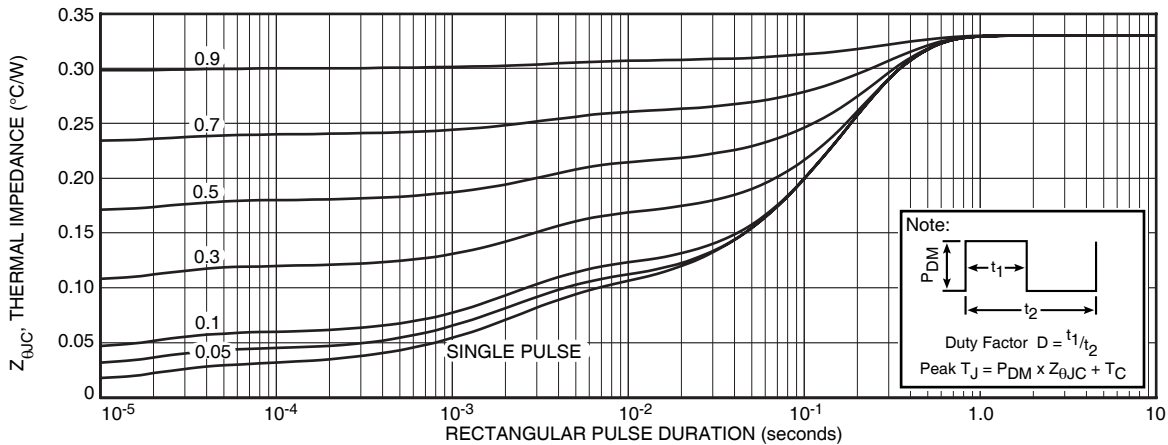

FIGURE 1a. MAXIMUM EFFECTIVE TRANSIENT THERMAL IMPEDANCE, JUNCTION-TO-CASE vs. PULSE DURATION

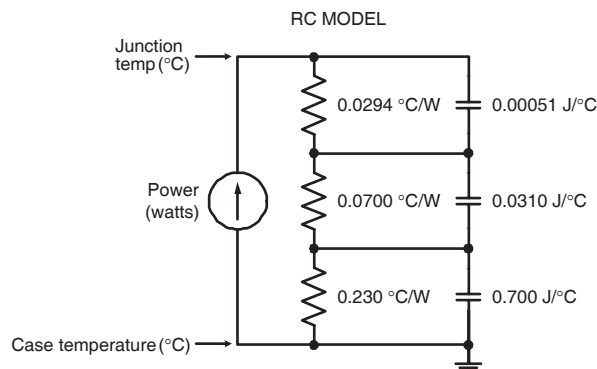

FIGURE 1b. TRANSIENT THERMAL IMPEDANCE MODEL

TYPICAL PERFORMANCE CURVES

APT2X101_100D20J

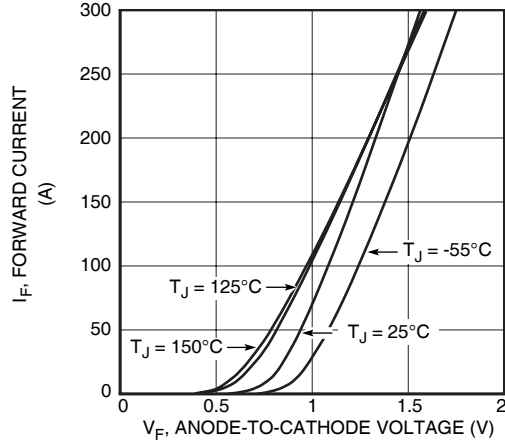

Figure 2. Forward Current vs. Forward Voltage

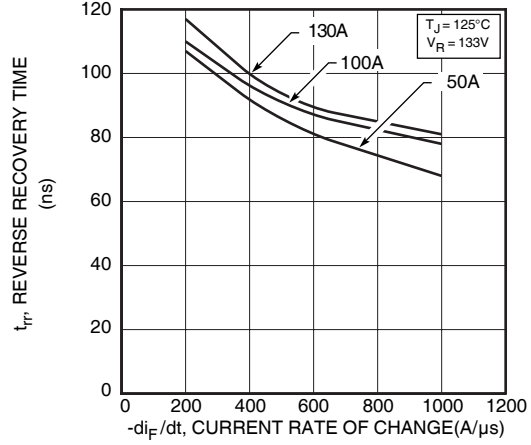

Figure 3. Reverse Recovery Time vs. Current Rate of Change

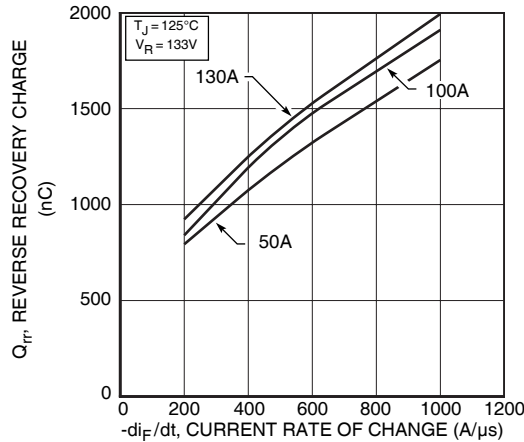

Figure 4. Reverse Recovery Charge vs. Current Rate of Change

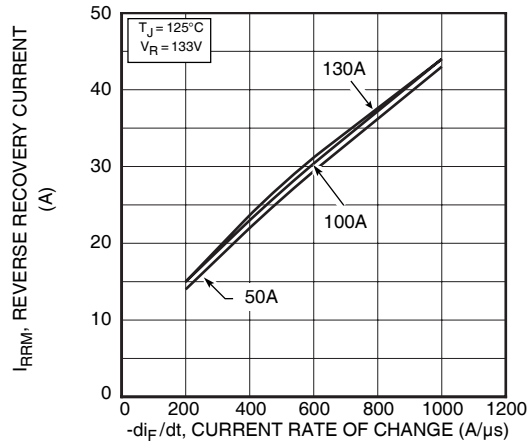

Figure 5. Reverse Recovery Current vs. Current Rate of Change

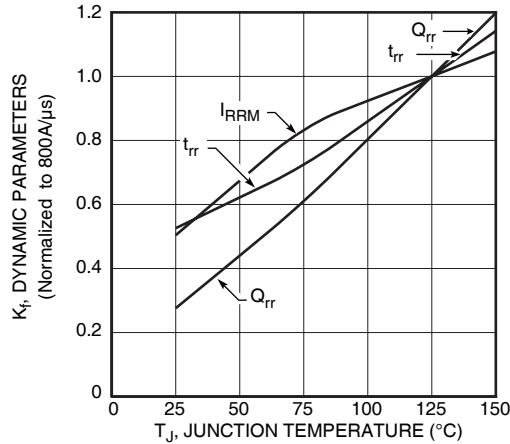

Figure 6. Dynamic Parameters vs. Junction Temperature

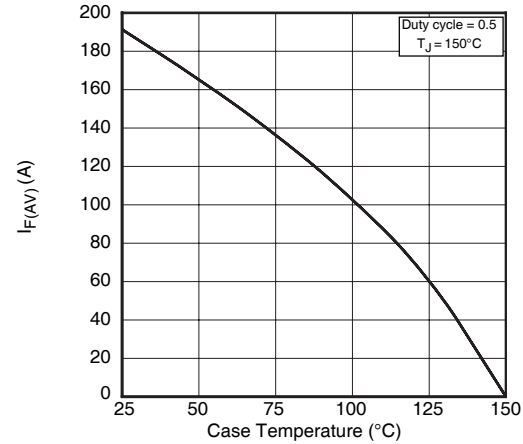

Figure 7. Maximum Average Forward Current vs. Case Temperature

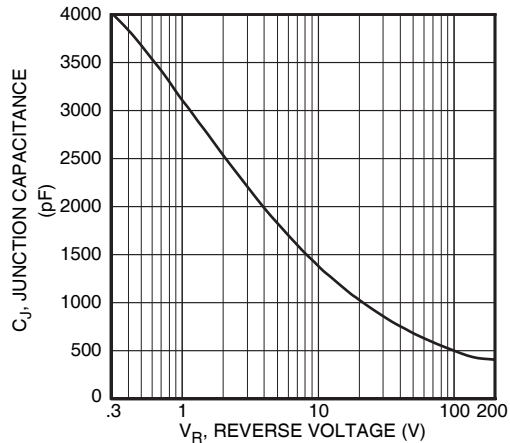

Figure 8. Junction Capacitance vs. Reverse Voltage

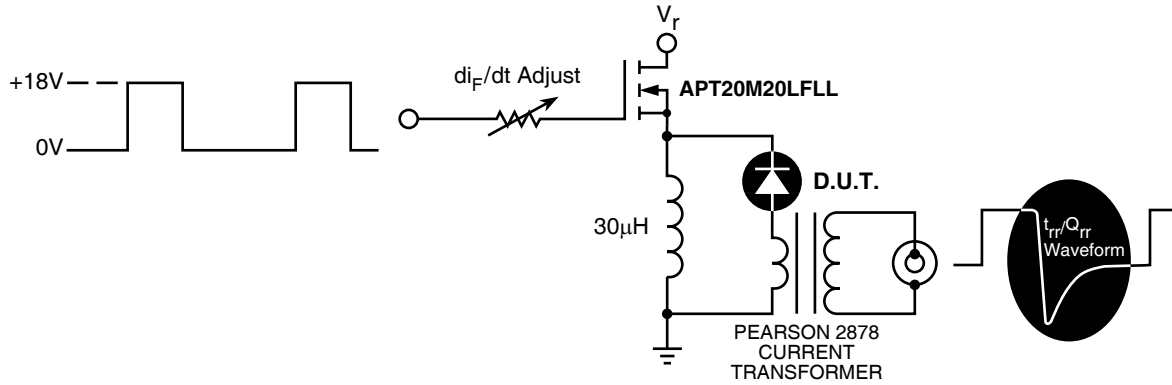

Figure 9. Diode Test Circuit

- 1 I_F - Forward Conduction Current
- 2 di_F/dt - Rate of Diode Current Change Through Zero Crossing.
- 3 I_{RRM} - Maximum Reverse Recovery Current.
- 4 t_{rr} - Reverse Recovery Time, measured from zero crossing where diode current goes from positive to negative, to the point at which the straight line through I_{RRM} and $0.25 \cdot I_{RRM}$ passes through zero.
- 5 Q_{rr} - Area Under the Curve Defined by I_{RRM} and t_{rr} .

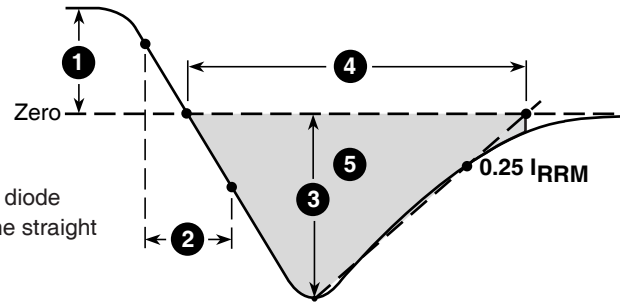
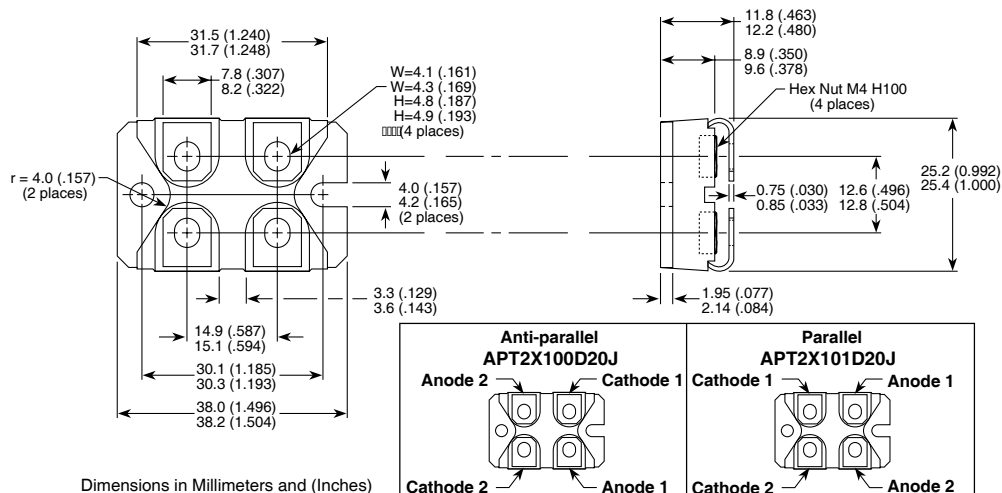
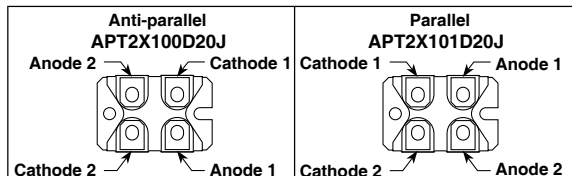

Figure 10, Diode Reverse Recovery Waveform and Definitions

SOT-227 Package Outline



Dimensions in Millimeters and (Inches)



ISOTOP® is a Registered Trademark of SGS Thomson. APT's products are covered by one or more of U.S. patents 4,895,810 5,045,903 5,089,434 5,182,234 5,019,522 5,262,336 6,503,786 5,256,583 4,748,103 5,283,202 5,231,474 5,434,095 5,528,058 and foreign patents. US and Foreign patents pending. All Rights Reserved.